

# MPPT Solar Charge Controller

MC4860N15/MC4870N15/MC4860N25/MC4870N25

## User Manual



# Dear Users:

## Thank you for choosing our products!

### Safety Instruction

- 1) The applicable voltage of the controller is beyond safety voltage of personnel. Before operation, please read the instruction manual carefully and start operating only after receiving safe operation training.
- 2) There is no parts requiring repair or maintenance within the controller, so please don't disassemble or repair the controller without authorization.
- 3) Please install the controller indoors and prevent water against entering into the controller.
- 4) Please install the controller in a well-ventilated place and the cooling fans in operation have high temperature.
- 5) It is suggested to install a suitable fuse or breaker outside of the controller.
- 6) Before installing and adjust the controller wiring, please break the connecting wire of the solar panel battery and the fuse or breaker close to the battery terminal.
- 7) After installation, inspect whether all wires are connected firmly to avoid any hazard caused by accumulated heat owing to poor contact.



#### Warning:

Indicating that the operation is hazardous, please fully prepared for safety before operation.



#### Notice:

Indicating that the operation is destructive.

## Table of Contents

<b>1. Introduction to Product</b>	03
1.1. Product Overview	03
1.2. Product Characteristics	03
1.3. Description of Appearance and Interface	04
1.4. System Wiring Schematic Diagram	05
1.5. Introduction to Maximal Power Tracking Technology	06
1.6. Introduction to Charging Stage (MPPT, Constant Voltage and Current)	06
<b>2. Technical Parameter</b>	08
2.1. Electrical parameter	08
2.2. Battery Type Parameter by Default	09
<b>3. State instruction for indicator light</b>	09
3.1. Charge state indication	09
3.2. State Display of Battery	10
3.3. Type Indication of Battery	10
<b>4. Key</b>	10
4.1. Key function I: set battery type	10
4.2. Key function II: recover factory default parameter	10
<b>5. Parameter Setting and Special Function Use</b>	11
5.1. Monitoring Use of Mobile Phone APP (Standard Configuration)	11
5.2. Application of Lead Acid Battery	11
5.3. Application of Lithium Battery	11
5.4. Setting of Charging Current	11
5.5. Definition of RS485 Communication Interface	12
5.5.1. Set as communication mode	12
5.5.2. Set as parallel operation mode	12
5.5.3. Remote on/off of charger	12
5.6. TTL Communication	12
5.7. Temperature Sampling of Battery	12
5.8. Voltage Compensation Wire of Battery	13
5.9. Programmable Relay Output	13
5.10. Use of Parallel Operation Function	13
<b>6. Liquid Crystal Display</b>	14
6.1. Menu Schematic Diagram	14
6.2. Menu Browse	15
6.3. Set System Parameter via LCD	15
6.4. Abnormal Code Display	16
6.5. Common Problem and Treatment Method	17
6.6. Installation Size of LCD	17
<b>7. Product Installation</b>	18
7.1. Installation Notice	18
7.2. Wiring Specification	18
7.3. Installation and Wiring	18
<b>8. Protection Function</b>	20
8.1. Introduction to Protection Function	20
<b>9. System Maintenance</b>	21
<b>10. Product Dimension</b>	21
<b>11. System wiring diagram</b>	22

# 1. Introduction to Product

## 1.1 Product Overview

The controller adopts the leading PowerCatcher maximal power Tracking technology in the industry to achieve maximal energy Tracking for solar panel, so that it can quickly and accurately trace the maximal power point of the solar battery, acquire the maximal energy of the solar panel and significantly improve the energy utilization ratio of the solar system. Widely applied to solar off-line photovoltaic system for managing solar panel and storage battery in operation, the controller is the core control component of off-line photovoltaic system.

The inside of the controller possesses sound electronic failure detecting and protection function to avoid the product component damage caused by installation error and system failure.

The controller is equipped with an LCD display screen to simultaneously support data interaction, setting and other operations with mobile phone APP, PC upper computer and other devices.

## 1.2 Product Characteristics

- ◆ PowerCatcher maximal power Tracking technology can still trace the maximal power point of solar battery in the complicated environment. Compared with traditional MPPT Tracking technology, it enjoys higher response speed and higher Tracking efficiency.
- ◆ MPPT charge efficiency is greater than traditional PWM charge efficiency by about 15% ~20%.
- ◆ MPPT Tracking efficiency can be as much as 99.9%.
- ◆ Adopting advanced digital power technology, the circuit energy conversion efficiency can be as much as 98%.
- ◆ The products support lithium batteries, charging output has active voltage stabilization function. In case of open circuit of lithium batteries or BMS overcharging protection, the storage battery end of the controller shall output stable target voltages in time, thereby possessing good lithium electric activation function.
- ◆ Preset a variety of battery types: lithium batteries, sealed batteries, colloidal batteries, open batteries and self-definition.
- ◆ Lead-acid batteries support temperature compensation function.
- ◆ With charging line loss compensation, the voltage of the battery terminal can be accurately controlled.
- ◆ With current-limiting charging, in case of too much battery panel power (charging current is greater than rated current), the controller automatically reduces the charging power so that it can operate within the rated charging current.
- ◆ With built-in overtemperature protection mechanism, when the temperature exceeds the set temperature value, the charging power shall decline in a linear way with the temperature.
- ◆ It supports parallel function and breaks through the power limit of single unit. Therefore, combination of several units can meet greater charging power.
- ◆ With built-in bluetooth 4.0BLE module, it can achieve mobilephone APP data interaction.
- ◆ Supporting standard Modbus protocol, it provides protocol technology support to facilitate secondary development and application by users.
- ◆ Programmable relay output

# 1.3 Description of Appearance and Interface

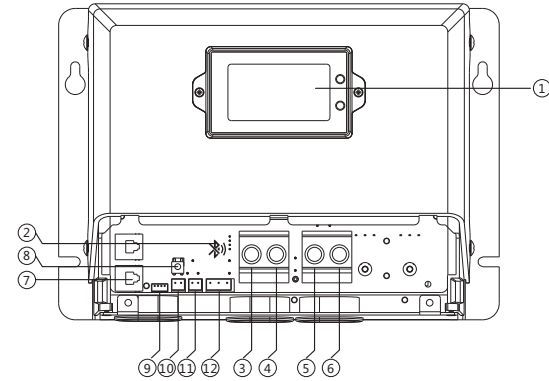

No.	Name	No.	Name
①	Liquid crystal display (LCD)	⑦	RS485 communication interface
②	Bluetooth 4.0BLE module	⑧	Key
③	Positive interface of battery	⑨	TTL communication interface
④	Negative interface of battery	⑩	Battery temperature sampling interface
⑤	Negative interface of solar panel	⑪	Battery voltage sampling interface
⑥	Positive interface of solar panel	⑫	Relay output interface

**Note: Negative poles of storage battery and solar battery are a common negative pole design.**

## 1.4 System Wiring Schematic Diagram

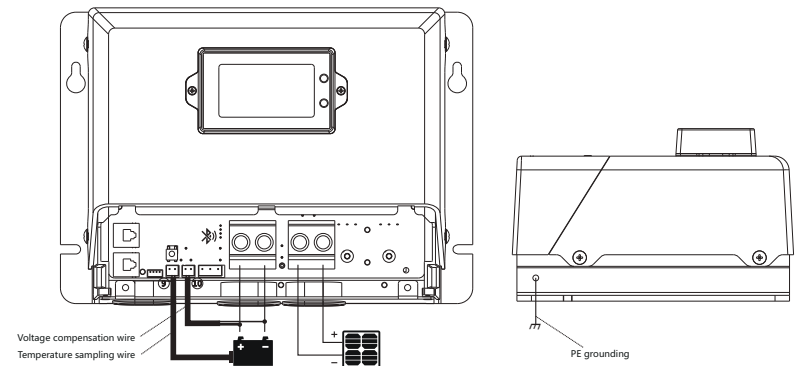

## 1.5 Introduction to Maximal Power Tracking Technology

Maximal power point tracing system is an advanced charge technology where the operation state of the electric module is adjusted so that the solar battery can output more electric energy. Owing to the nonlinear characteristics of solar battery array, there is an array of maximal energy output point (maximal power point), the traditional controller (on-off charging technology and PWM charging technology) cannot maintain storage battery charging at this point. Therefore, it is unable to acquire the maximal energy of battery panel. However, the solar controller with MPPT control technology can trace the maximal power point of the array to acquire the maximal energy to charge the storage battery.

Taking 12V system as the example, the peak voltage ( $V_{pp}$ ) of solar battery is about 17V, but the storage battery voltage is about 12V, when general charge controller is charging, the voltage of the solar battery is about 12V, the maximal power is not fully exerted. MPPT controller can overcome the problem and adjust the input voltage and current of the battery panel from time to time so that the input power can be the maximal value.

Comparing with traditional PWM controller, MPPT controller can exert the maximal power of solar battery.

Therefore, bigger charge current can be provided. Generally speaking, compared with PWM controller, MPPT can improve energy utilization ratio by 15%~20%.

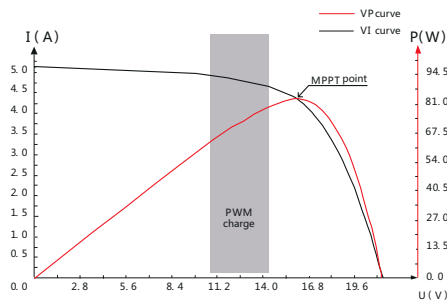

Fig.1-2 Output Characteristic Curve for Solar Battery

Owing to different ambient temperature and illumination conditions, maximal power point can change frequently. Our MPPT controller can adjust parameters according to different conditions so that the system can be close to the maximal operation points at any time. The whole process is completed fully automatically without any adjustment by users.

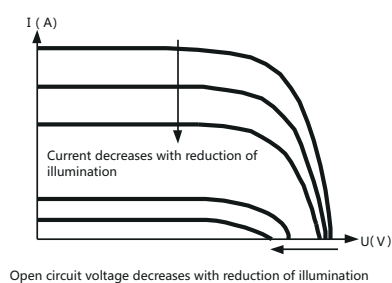

Fig.1-3 Relation Between Solar Battery Output Characteristics and Illumination

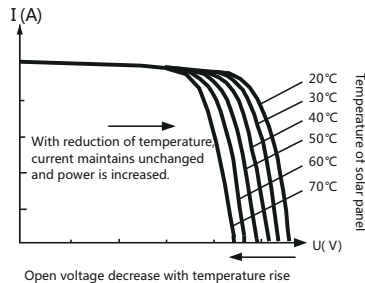
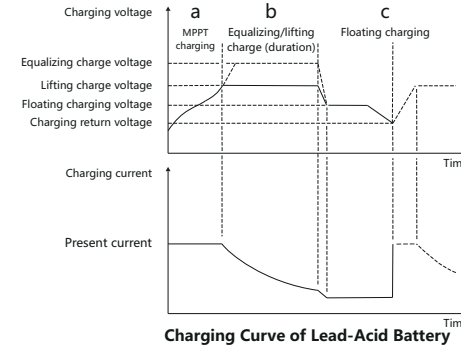

Fig.1-4 Relation Between Solar Battery Output Characteristics and Illumination

## 1.6 Introduction to Charging Stage (MPPT, Constant Voltage and Current)

### 1.6.1 Charging process of lead-acid battery

As one of the charging processes of lead-acid batteries, MPPT usually needs to be combined with equalizing charge/lifting charge, floating charging and other charging methods to jointly complete the charging management for storage batteries.



Charging Curve of Lead-Acid Battery

The charging stages of lead-acid batteries include MPPT charging, constant voltage charging (equalizing/lifting/floating charging) and current limiting charging.

#### a) MPPT charge

In MPPT charging stage, the battery voltage has not reached the target constant voltage value, so the controller will perform MPPT charging to maximize the charge amount from solar energy quantity to the storage battery. After the storage battery voltage reaches the constant voltage value, it shall automatically change to constant voltage charging.

#### b) Constant voltage charge

When the storage voltage reaches the target constant voltage value, the controller shall exit from MPPT charging and enter into constant voltage charging. With the progress of constant voltage charging, charging current shall drop gradually with time lapse. Constant voltage charging is divided into two stages, namely equalizing charge and lifting charge respectively. These two charging process shall not repeated (the equalizing charge interval is 30 days at a time by default).

#### c) Equalizing charge



#### Warning: Explosion Risk!

Equalizing open-head lead-acid batteries can produce explosive gases and battery compartments must be well ventilated.



#### Note: Device Damage!

Equalizing may increase battery voltage, but damage the level of sensitive DC load. Therefore, it is necessary to validate that the allowable input voltage of all loads is greater than the set equalizing charge value.



#### Note: Device Damage!

Excessive charging and gas evolution may damage polar board of storage and result in peeling of active substances on the battery plate. Too high equalizing charge voltage or too long charging time may damage batteries. Please set related parameters according to the specification requirements of the batteries used in the system.

Some types of batteries benefit from periodic equalizing charge, which mainly increases the charging voltage of batteries so that it is higher than the standard supply voltage. Equalizing charge can gasify the battery electrolyte, balance the battery voltage and complete the chemical reaction. Equalizing charge and lifting charge are not repeated in a charging process to avoid too much precipitated gas or overheated battery.

### ➤ Lifting charge

Generally, it is considered that the lifting charge stage lasts for 2h by default. When the duration reaches the set value, the system shall turn to the floating charge (lifting charge duration: only the self-defined battery type can be changed).

### ➤ Floating charge

Floating charge is the last stage for constant voltage of lead-acid storage. The controller keeps the charging voltage at the floating charge voltage. At this stage, weak current charge is performed for the battery at this stage to guarantee that the battery maintains at the full charging state.

At floating charge stage, when the battery voltage drops to the lifting charge return voltage, after a period of time, the system shall exit from the floating charge stage and then enter into MPPT charge stage again.

#### 1.5.21.5.2 Charging Process of Lithium Battery/Customized Lithium Battery

The charging stages of lithium batteries contain MPPT charging, constant voltage charging, and current-limiting charging

##### a) MPPT charging

In MPPT charging stage, the battery voltage has not yet reached the target constant voltage. The controller will perform MPPT charging to maximize the charge amount from solar energy quantity to the storage battery. After the storage battery voltage reaches the constant voltage value, it shall automatically change to b) constant voltage charging.

##### b) Constant Voltage Charging

Lifting charge is the unique constant voltage charge state. Therefore, only when the storage voltage drops to the set value for lifting and recovering charge, the system can exit from the constant voltage charging stage and then enter into MPPT charging stage again.

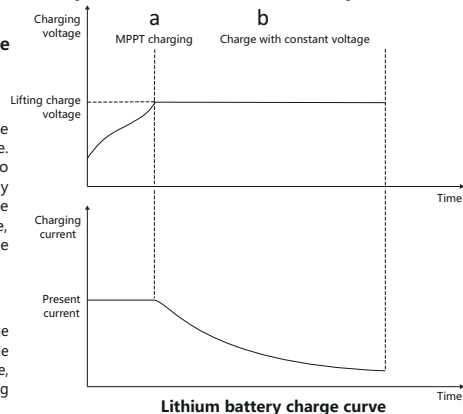

#### 1.5.3 Current-limiting charge over rated current

Current-limiting charge runs through the whole charging cycle. In any charging stage, as long as it is detected that the current is beyond the rated current, it shall enter into the current-limiting charge automatically and the charging current is limited to the rated current.

#### 1.5.4 Overtemperature and Current-Limiting Charge of Device

Overtemperature and current-limiting charge of device runs through the whole charging cycle. In any charging stage, as long as overtemperature of device is detected, it will automatically enter into linear current-limiting charge.

## 2. Technical Parameter

### 2.1 Electrical parameter

Name of Parameter	Parameter Value			
Type	MC4860N15	MC4870N15	MC4860N25	MC4870N25
System Voltage	12V/24V/36V/48V			
No-load loss	0.54W			
Battery voltage	9V~64V			
Maximal PV open-circuit voltage	150V		250V	
Maximum PV short-circuit current	50A		40A	
Maximal voltage range at power point	Battery voltage +2~110V		Battery voltage +2~180V	
Rated charging current	60A	70A	60A	70A
Settable charging current	0-60A	0-70A	0-60A	0-70A
Power of solar panel (12V)	800W	920W	800W	920W
Power of solar panel (24V)	1600W	1840W	1600W	1840W
Power of solar panel (48V)	3200W	3680W	3200W	3680W
Charging conversion efficiency	≤98%			
MPPT tracing efficiency	> 99%			
Temperature compensation coefficient	-3mV/°C/2V (default, settable lead-acid); no temperature compensation for lithium battery.			
Communication way	TTL/Isolated RS485; baud rate 9600, digital bit 3, stop bit 1, no check bit			
Bluetooth	Built-in bluetooth 4.0BLE module, achieving mobilephone APP monitoring			
Internal temperature protection	When interior temperature of controller is higher than the set value, it shall perform linear power reduction operation			
External temperature sampling of battery	The temperature is used for battery temperature compensation and battery temperature protection			
Programmable relay	DPST 10A/250VAC ; 10A/30VDC			
Protection function	Battery overcharging protection, battery over discharge protection, PV anti-reverse protection, reverse charge protection at night, interior overtemperature protection of controller and over-current protection in charge			
Operation temperature	-35°C ~ +65°C(No derating within 40 °C)			
Elevation	≤3000m			
Protection grade	IP32			
Weight	3.6kg			
Product size	Conventional : 266*194*119mm MC4 : 266*226*119mm			

## 2.2 Battery Type Parameter by Default

Parameter Contrast of Different Types of Battery					
Battery type Set Voltage	Sealed lead-acid battery	Colloidal lead-acid battery	Open-head lead-acid battery	Lithium battery	Self-defined User (12V by default)
Overvoltage breaking voltage	16.0V	16.0V	16.0V	16.0V	9~17V
Equalizing voltage	14.6V	—	14.8V	—	9~17V
Lifting voltage	14.4V	14.2V	14.6V	14.4V	9~17V
Floating voltage	13.8V	13.8V	13.8V	—	9~17V
Lifting recovery voltage	13.2V	13.2V	13.2V	13.2V	9~17V
Overdischarge recovery voltage	12.6V	12.6V	12.6V	12.6V	9~17V
Undervoltage alarm	12.0V	12.0V	12.0V	12.0V	9~17V
Overdischarge voltage	11.1V	11.1V	11.1V	11.1V	9~17V
Overdischarge cutoff	10.6V	10.6V	10.6V	10.6V	9~17V
Overdischarge delay	6S	6S	6S	6S	1-30S
Equalizing charge interval	30days	0days	30days	—	0~250days (0 indicate dosing and equalizing charge function)
Equalizing duration	120 minutes	—	120 minutes	—	10~600 minutes
Lifting duration	120 minutes	120 minutes	120 minutes	—	10~600 minutes
Temperature compensation mV/°C/2V	-3	-3	-3	—	Automatic removing temperature compensation for lithium

## 3. State instruction for indicator light

### 3.1 Charge state indication

No.	State of Indicator Light	Charge State
①	Normal on	MPPT Charge
②	Slow flash (on 1s, off 1s, period 2s)	Lifting charge
③	Single flash (on 0.1s, off 1.9s, period 2s)	Floating charge
④	Quick flash (on 0.1s, off 0.1s, period 0.2s)	Equalizing charge
⑤	Double flash (on 0.1s, off 0.1s, on once again 0.1s, off once again 1.7s, period 2s)	Current limiting charge
⑥	Off	No charge is started

## 3.2 State Display of Battery

Color of Indicator Light	State of Indicator Light	State of Battery
Green	Normal on	Full battery voltage
Yellow	Normal on	Normal battery voltage
Red	Normal on	Battery voltage is below the undervoltage point
	Quick flash (on 0.1s, off 0.1s, period 0.2s)	Battery overvoltage or overtemperature

## 3.3 Type Indication of Battery

Color of Indicator Light	Type of Battery
Red	Open-head lead acid battery FLD
Yellow	Colloidal lead acid battery GEL
Green	Sealed lead acid battery SLD
Blue	12V lithium battery LI (lithium iron phosphate by default)
Purple	24V lithium battery LI (lithium iron phosphate by default)
Orange	36V lithium battery LI (lithium iron phosphate by default)
Cyan	48V lithium battery LI (lithium iron phosphate by default)
White	Self-defined USE (12V sealed lead acid by default)

## 4. Key

### 4.1 Key function I: set battery type

Press the key for 8s and the battery type indicator light starts flickering (the controller can turn off the charge at this time). At this time, after each press, the battery type indicator light turns to another color and there is a corresponding battery type. After the battery type is selected, press the key for 8s once again or 15s after no operation, the controller shall automatically save the battery type set at present and exit from the setting mode and enter into the normal operation mode; (LCD is the standard configuration. Generally, this method is not used for setting).

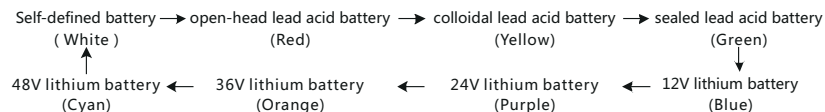

### 4.2 Key function II: recover factory default parameter

Press the key for 20s and the red indicator light of the three ones on the controller flickers and the controller is restored to the factory default parameters.

## 5. Parameter Setting and Special Function Use

### 5.1 Monitoring Use of Mobile Phone APP (Standard Configuration)

Blue tooth 4.0BLE module is integrated in the controller and users can use the mobile phone APP developed by our corporation to achieve data monitoring, setting and other operations to the controller.

Please contact business personnel to get related software and operation instruction.

### 5.2 Application of Lead Acid Battery

1) The LCD screen on the controller (see 6.3 set system parameters via the LCD screen) or mobile phone APP can be used to select the battery type matched with the battery. The changed system voltage can be effective only upon restart.

2) If the preset lead-acid battery parameters are not suitable for the battery used by users and users can use customization. All parameters customized can be set only through communication, such as mobile phone APP, PC client software, or perform communication setting via other user system in accordance with communication protocol and controller.

(At delivery: the self-defined default values are same as the sealed lead acid battery parameters. The system voltage is 12V)

### 5.3 Application of Lithium Battery

Preset LI for controller containing lithium iron phosphate of specifications 12V/24V/36V/48V. If the preset values for the lithium battery are not suitable for users, you can perform communication setting with the controller via mobile phone APP, LCD screen of the device, external LCD screen and other systems according to the communication protocol through other systems of the user.

Customization may be lead-acid batteries or lithium batteries. To apply lithium batteries in the self-defined battery type, it is required to meet the following conditions:

- 1) Set a fixed voltage for the system voltage, one of 12V/24V/36V/48V.
- 2) Equalizing charging time interval is set as 0;
- 3) Equalizing charging time is set as 0;
- 4) Temperature compensation is set as 0.

**Meeting the above four conditions, the system automatically identifies the batteries as lithium batteries. Therefore, the system possesses lithium battery activation, charging and other charge control logic.**

### 5.4 Setting of Charging Current

The rated current of the controller is 100A, which supports the setting of communication instructions, ranging from 0.00 A to 100.00A. Via mobile phone APP or the user system provided by our company, communication setting is performed for specified register E001H with the controller via the mobile phone APP or the user system according to the protocol. Please refer to our Modbus protocol for setting and analysis.

## 5.5 Definition of RS485 Communication Interface

- 5.5.1 Set as communication mode

Users can utilize Modbus protocol to perform data monitoring, parameter setting and other operations via the port for the controller via the port.

- 5.5.2 Set as parallel operation mode

The parallel operation mode can be used only after the device is set as parallel operation mode,

- 5.5.3 Remote on/off of charger

Two pieces of remote on/off input signal are integrated in 485 communication wire.

The charging can be broken only by short circuit of pins ⑤ and ⑥ in the communication wire.



No.	Definition	No.	Definition
①	Isolate positive power supply	⑤	Remote on/off of charger
②	D+	⑥	Remote on/off of charger
③	D-	⑦	NC
④	Isolate power ground	⑧	NC

## 5.6 TTL Communication

Users can utilize Modbus protocol to perform data monitoring, parameter setting and other operations for the controller via the port.

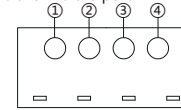

No.	Definition
①	Controller supplies +12.8V outwards.
②	Data receiving terminal RX of controller
③	Data sending terminal TX of controller
④	GND

## 5.7 Temperature Sampling of Battery

Not connected to temperature sensor, it is 25°C by default; After the temperature sensor is connected, high and low temperature protection is performed or charging temperature compensation is performed for the battery (there is no temperature compensation for lithium battery).

Wiring method: the wiring terminal of the temperature sensor is connected to (9) and the temperature sensor is fixed thereon.

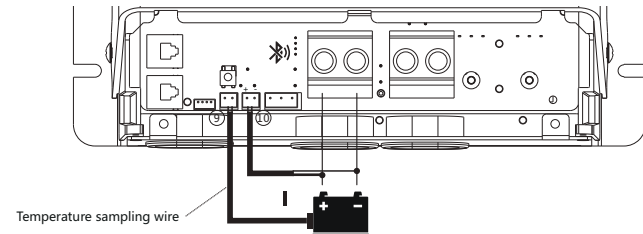

## 5.8 Voltage Compensation Wire of Battery

Owing to the configuration, the charging power is great and the diameter of wire from battery to the controller is small. Therefore, the voltage collected by the controller terminal is greater than the practical voltage of the battery terminal and the battery cannot be fully charged. In certain degree, the voltage of the battery terminal can be more accurately collected via the voltage sampling wire of the battery and the voltage difference can be output in a compensated way, so that the battery terminal can get more reasonable charging voltage.

The positive and negative poles of the battery are respectively connected to the positive and negative poles of the battery voltage sampling terminal (10) via the voltage compensation wire. Please note that the left is the positive terminal and the right is the negative terminal.

The wiring way is shown in the figure below:

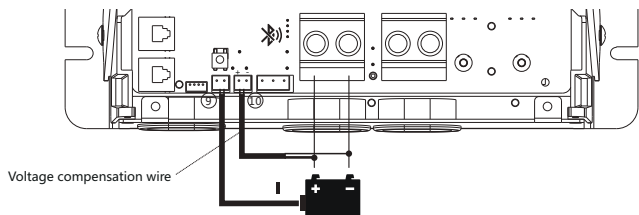

## 5.9 Programmable Relay Output

- Single-pole double-throw (DPST) relay
- Relay contact specification 250VAC/10A, 30VDC/10A
- From left to right, there are NC contacts, common points and NO contacts.

Relay triggering condition:

- 1) When battery voltage is normal, the relay coil doesn't operate in NC state (C and NC are conducted)
- 2) In case of overvoltage or over discharge of the battery, relay coil operates in NO state (C and NO are conducted)

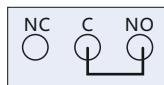
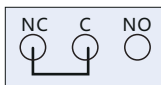

## 5.10 Use of Parallel Operation Function

### 5.10.1 Parallel operation function:

Parallel operation function means that several controllers charge one battery pack one to one uniformly. Each controller has one independent solar panel; these controllers are connected via RS485 communication wires and the host system uniformly synchronizes the charge state stage, constant voltage value and other parameters to the slave. In this way, the device can break through the power limit of single device. In addition, parallel operation of several devices can meet greater charging power demands.

### 5.10.2 Setting parallel operation method:

- ① Press and hold two buttons "ENTER" and "SELECT" on the LCD screen at the same time to pop up the parallel operation menu. At this time, the menu can only be used for viewing and displaying P-XX or C-XX;
- ② Press and hold "ENTER" for 2s to enter the setting mode. At this time, icon flickers;
- ③ Press "ENTER" to switch to the parallel operation function P-XX;
- ④ Then press "SELECT" to set the equipment address, and "SELECT" to add 1. At this time, immediately press "ENTER" to decrease 1 from the address;
- ⑤ After the setting is completed, 5s after no button is pressed, the setting is automatically stored and the device exit to the main interface.

**Remark: P = Parallel: indicating that RS485 communication terminal is set as the parallel operation function for use;**

RS485 communication terminal is set as the parallel operation function;  
C:=Communication: indicating that RS485 communication terminal is set as common communication function for use;  
XX: indicating equipment address range 00~99.

## 6. Liquid Crystal Display

LCD module as the standard configuration of the controller can be installed on the controller surface or in other places via DB9 extension wire in accordance with practical conditions.

### 6.1 Menu Schematic Diagram

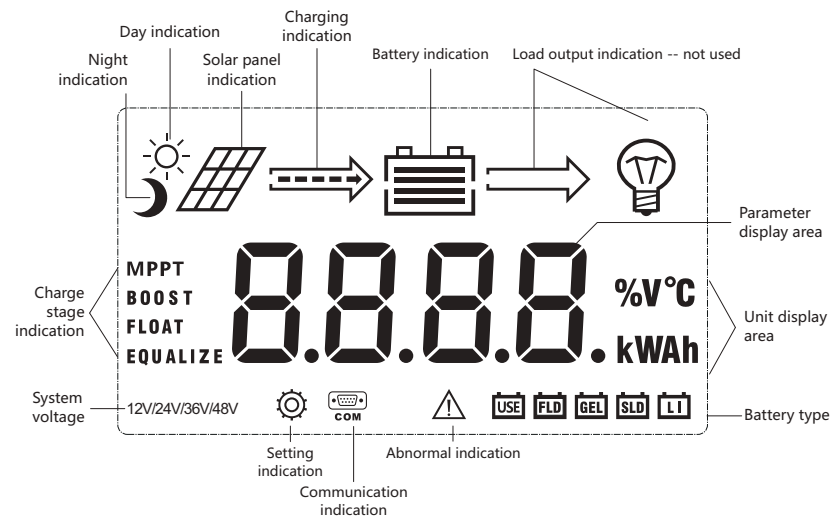



## 6.2 Menu Browse

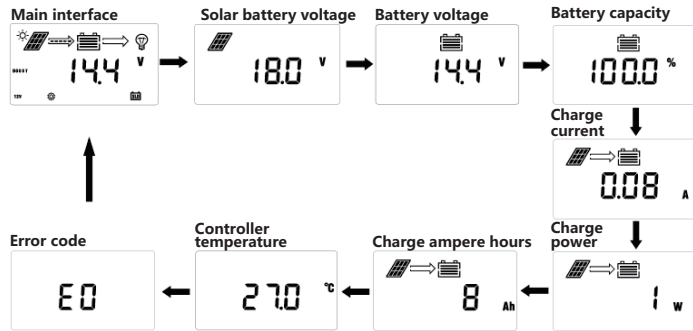

## 6.3 Set System Parameter via LCD

### Setting method:

1). Under any menu, press key "ENTER" for long time to enter into "Parameter Setting" menu:

- (1) Press key "ENTER" for short time and adjust the parameter value;
- (2) Press key "SELECT" for short time and select setting item;
- (3) Press key "ENTER" for 2 seconds, save and exit from setting mode;
- (4) Select "FLD/GEL/SLD/LI" battery type and press key "SELECT" to only perform switching between "system voltage" and "battery type".
- (5) After selecting "USE" for customizing battery type, press key "SELECT" for switchover among "system voltage"/"equalizing charging voltage/lifting charging voltage/floating voltage/over discharge return voltage/over discharge voltage".

### Note:

- (1) The changed "system voltage" can be effective only after poweron again.
  - (2) Users must be careful while customizing parameters. The system may not operate normally owing to inaccurate parameter!
- 2) Customized USE menu

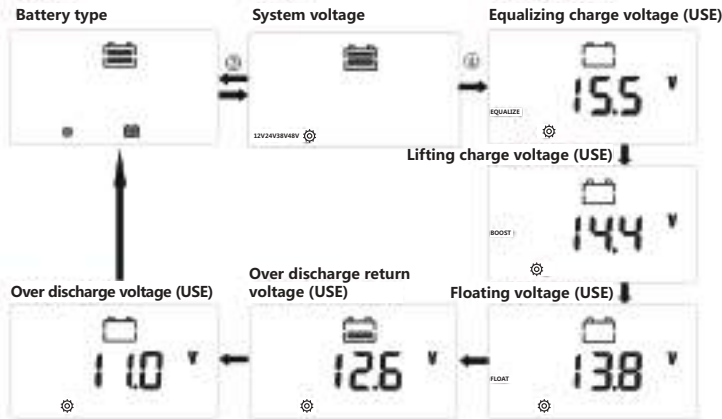

No.	Liquid Crystal Display	Set Item	Parameter Range	Remark
1	USE	Battery type	--	Customizing battery type
2	12V/24/36V/48V	System voltage	12V/24/36V/48V	"12V/24/36V/48V" simultaneous on indicates automatic identification
3	EQUALIZE	Equalizing charging voltage (USE)	9.0 ~ 17.0V	--
4	BOOST	Lifting charging voltage (USE)	9.0 ~ 17.0V	--
5	FLOAT	Floating charging voltage (USE)	9.0 ~ 17.0V	--
6		Over discharge recovery voltage (USE)	9.0 ~ 17.0V	--
7		Over discharge voltage (USE)	9.0 ~ 17.0V	--

## 6.4 Abnormal Code Display

No.	Error Code Displayed by LCD	Note	Implementation Result
1	E0	No abnormality	Normal system
2	E1	Battery over discharge	Battery voltage rises to over discharge return voltage and over discharge prompt is released.
3	E2	Battery over voltage	No charging
4	E3	Under voltage alarm of battery	Battery voltage is lower than undervoltage alarm threshold value, it is only prompted that the system is normal.
7	E6	Interior over temperature of controller	Excessive internal temperature of controller, MPPT controller starts linear power charge; it shall recover automatically after reducing to certain value.
8	E7	Battery over temperature	Turn off the charging and then recover the charging automatically after the voltage is lower than certain value.
9	E8	Excessive charge current of input power of solar panel	MPPT controller is limited within rated current range
10	E10	Over voltage of solar panel	Over voltage of solar panel, turn off the charging and recover the charging when the voltage is lower than the set value.
12	E15	Battery not connected or feedback electricity of lithium battery	As long as the solar panel voltage meets the charging condition, lithium battery has constant voltage output, lead-acid battery has no voltage output, and it shall recover to normal after the battery is connected.
13	E16	Over temperature of battery	No charging
15	E18	BMS over charge protection	No charging
16	E19	Low temperature of battery	No charging

## 6.5 Common Problem and Treatment Method

Phenomenon	Treatment Method
Indicator light or LCD is not on	Please check whether battery and solar panel are correctly connected.
No datum on LCD	Poor communication; check the communication wire.
There is voltage on the solar panel, no voltage output at battery end, display code E1	No battery can be detected at the lead-acid battery terminal. There is no voltage output from both ends of the battery. It shall return to normal state after battery is connected.
Connected with 12V/24V/36V/48V normal voltage battery and the battery icon on the LCD flashes slowly, display error E1	Check whether it is set as corresponding system voltage or automatic identification, restart the controller; After setting the system voltage, it is designed for safety and can be effective only after restart.
Battery icon indicator light flashes quickly without charging. Display code E1	Overvoltage of system; inspect the overvoltage reason of the battery. It shall restore after reduction of voltage.
The device cannot be searched by mobile phone Bluetooth.	Inspect whether other mobile phones are connected with the Bluetooth setting.
No charging by controller.	Inspect whether wires are correctly connected, whether solar panel voltage exceeds the rated value, whether battery exceeds the voltage, check LCD error code. Inspect whether there is interior overtemperature, exterior overtemperature, low temperature of exterior lithium, or whether the lead-acid battery is open, etc.
Other problem or insoluble abnormality	Try to restore the factory setting and then set related parameters in accordance with system configuration. Take care in the operation!

## 6.6 Installation Size of LCD

Product size:104.5\*55.5\*11.8mm

Installation size: 96\*φ3.5mm

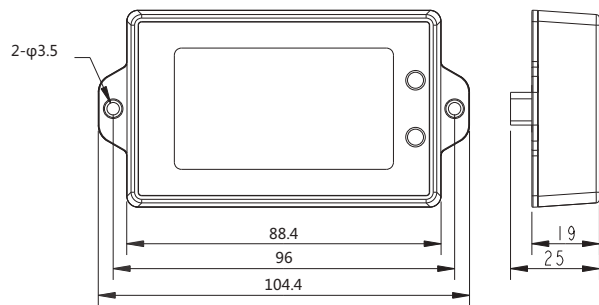

## 7. Product Installation

### 7.1 Installation Notice

- ◆ Please be careful in battery installation. To open the open-head lead-acid battery, it is required to wear a pair of goggles. Once contacting the acid liquid of the battery, please flush with clear water immediately.
- ◆ Avoid placing metal articles close to the battery to prevent short circuit of battery.
- ◆ The battery in charging may generate acid gas, so please guarantee well-ventilated ambient.
- ◆ The battery may generate flammable gas, please keep away from spark.
- ◆ Please avoid direct sunlight and rain water in outdoor installation.
- ◆ The virtually connected points and corrosive wires may generate heat and melt the insulation layer of the electric wire, burn surrounding materials and even cause fire. Therefore, it is required to guarantee that all connectors are tightened. The electric wires shall be fixed with wire ties to avoid connector looseness in mobile application.
- ◆ To connect the system, the voltage at the output terminal of the component may exceed safe body voltage. Therefore, it is required to use insulation tools in operation and guarantee dry hands.
- ◆ The wiring terminal of the battery on the controller can be connected with only one battery, or with a set of battery. In the manual, the instructions are only for one battery. However, they are applicable to a set of batteries.
- ◆ Please observe the safe suggestion of the battery manufacturer.
- ◆ The system connecting wire is selected based on the current density no less than 4A/mm<sup>2</sup>.
- ◆ The ground terminal of the controller shall be grounded.
- ◆ In installation, the battery shall not be reversely connected, which may cause irreversible damage!

### 7.2 Wiring Specification

It is required to observe national and local electrical specification requirements for wiring and installation ways. PV and battery wiring specification must be selected based on rated current. Please refer to the table below for the wire specification.

Type	Maximal input current of PV	Maximal wire size at PV terminal (mm <sup>2</sup> /AWG)	Rated charge current	Wire size of battery (mm <sup>2</sup> /AWG)
MC4860N15	50A	13/6	60A	15/5
MC4870N15	50A	13/6	70A	18/4
MC4860N25	40A	10/7	60A	15/5
MC4870N25	40A	10/7	70A	18/4

### 7.3 Installation and Wiring

- Warning** : Explosion hazard! Never install the controller and open-head battery into an enclosed space or in an enclosed room with possible gathering of battery gas.
- Warning** : High voltage is hazardous! Photovoltaic array may generate high open voltage. Before wiring, please break the breaker or fuse. Please be careful during the connection process.
- Note** : To install the controller, please guarantee that there is enough air flowing through the cooling fin of the controller. At least leave 150mm space above or below the controller so as to guarantee natural and convective heat dissipation. If installed in an enclosed box, please guarantee reliable heat dissipation via the box.



Fig. 2.1 Installation and Heat Dissipation

#### Step 1: select an installation place

It is prevented to install the controller to a place with direct sunlight, high temperature and possible water inlet. In addition, it is required to guarantee well ventilation around the controller.

#### Step 2: fix screw

Mark a sign at the installation position in accordance with the installation size of the controller. Drill four installation holes with proper size at 4 marking positions. Afterwards, fix the screws to the upper two installation holes.

#### Step 3: fix controller

Align the fixing hole of the controller with two screws fixed in advance, then hang the controller and fix the lower two screws.

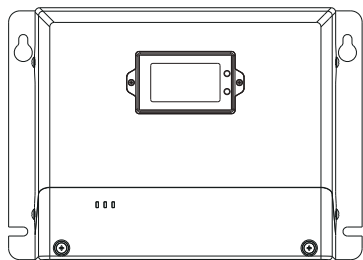

#### Step 4: Wiring

In order to guarantee safety in installation, we recommend a wiring sequence for the main circuit; it is prohibited to connect the positive and negative poles of the battery reversely!!!!

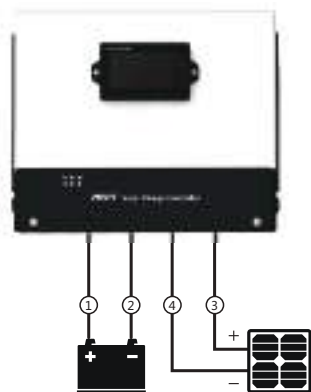

**Warning:** : Danger of electric shock! We strongly recommend to connect the fuse or breaker at the photovoltaic array and the battery terminals to prevent electric shock hazard in wiring or inaccurate operation. Furthermore, before wiring, it is required to guarantee that the fuse or breaker is in open state.

**Warning:** : Danger of high voltage! Photovoltaic array may generate high open voltage. Before wiring, please open the breaker or fuse,

**Warning:** : Danger of explosion! Short circuit of positive and negative terminals of battery and wires connected to the positive and negative poles may cause fire or explosion. Please take care in operation.

Please connect the battery at first and then the battery panel. Please observe the connecting way of pole "+" before pole "-".

When all power lines are connected firmly and reliably, inspect whether the wires are correct once again and whether the positive and negative poles are connected reversely. After it is confirmed that all are correct, connect the battery fuse or breaker at first and then observe whether LED indicator light is on. If the light is not on, please immediately cut the fuse or breaker, and then inspect whether the wires are correctly connected.

If the battery is connected normally, connect the battery panel. If the sunlight is sufficient, charging indicator light of the controller shall be normally on or flickers, start charging the battery.

**Warning:** install the battery fuse close to the battery terminal as far as possible. It is suggested that the installation distance shall not exceed 150mm.

## 8. Protection Function

### 8.1 Introduction to Protection Function

#### • Waterproof

Waterproof grade: IP32

#### • Overtemperature protection inside device

When interior temperature of the controller is beyond the set value, the controller shall reduce the charging power or even break automatically in charging to further slow down temperature rise in the controller.

#### • Overtemperature protection of battery

To achieve overtemperature protection of battery, it is required to connect the temperature sampling sensor of battery externally. When it is detected that the battery temperature is high, stop charging. When the battery temperature is reduced to be lower than the set value by 5°C, charge shall be restored automatically after two seconds.

#### • Overpower protection for input

When the battery panel power is greater than the rated power, the controller shall limit the charge power within the rated power range to prevent controller damage caused by excessive current. At this time, the controller shall enter into the current limiting charge.

#### • Overvoltage of photovoltaic input terminal

In case of excessive voltage at photovoltaic array input terminal, the controller shall automatically cut the photovoltaic input.

#### • Reverse protection for photovoltaic input

When the photovoltaic array polarity is connected reversely, the controller shall not damage and shall further operate after wiring error is corrected.

#### • Anti-reverse charge protection at night

It is required to prevent the accumulator against discharge via solar battery.

**Special notice: there is no reverse wiring protection function for battery.**

## 9. System Maintenance

In order to guarantee that the controller can maintain the optimum operation performance for long time, it is suggested to inspect following items regularly.

- Confirm that air flow around the controller cannot be blocked and clear away the dirt or sundries on the radiator.
- In case of abnormal failure or error prompt, adopt corrective measures in time.
- Inspect whether there is corrosion, insulation damage, high temperature, burning/dicolor sign on the wiring terminal, whether the shell is deformed. If any, perform repair or replacement in time.
- Any wire with exposure, damage, poor insulation performance shall be repaired or replaced in time.
- Any dirt, nesting, insect or corrosive phenomenon shall be cleared in time.

**Warning** : Danger of electric shock! To carry out above operation, please ensure that all power of the controller has been broken. Afterwards, perform corresponding inspection and operation! Any non-professional shall not operate without authorization.

## 10. Product Dimension

① Common size :

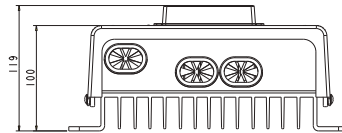
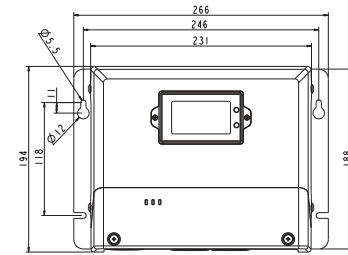
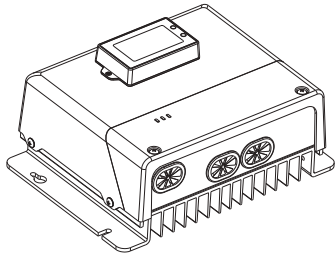

Product size:266\*194\*119mm  
Installation size:246\*118mm  
Fixing hole position: Φ5.5mm  
Wire specification:20-2AWG

②-MC4 size :

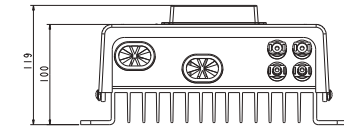
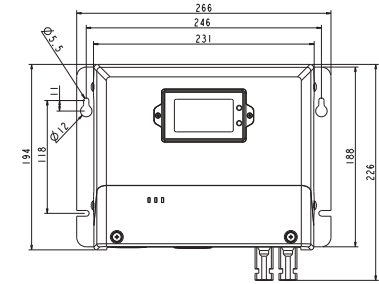
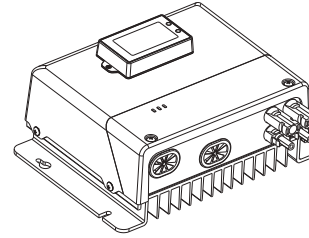

Product size : 266\*226\*119mm  
Installation size : 246\*118mm  
Fixing hole position : Φ5.5mm  
Wire specification : 20-2AWG

## 11. System wiring diagram

Stand-alone

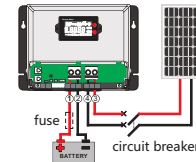

Parallel operation

